

# Washing machine

Instructions for installation and use

**WE 14**

 **INDESIT**



# Quick guide

Here are the 12 topics explained in this manual. Read, learn and have fun: you will discover many secret ways to get a better wash, more easily and making your washing machine last longer.

## 1. Installation and removal (p. 10)

Installation, after delivery or transport, is the most important operation for the correct functioning of your washing machine. Always check:

1. That the electric system conforms to regulations;
2. That the inlet and draining pipes are connected correctly.  
**Never use hoses that have already been used, always use the new ones provided with your machine.**
3. That the washing machine is levelled properly; something worth checking to aid the performance of your washing machine;
4. That the drum's fixing screws have been removed from the back of the washing machine;

## 2. What goes in your washing machine and how to start it (p. 2)

A correct distribution of your laundry is vital to the successful outcome of the wash and the life of the washing machine. Learn all the tips and secrets to dividing your linen: colour, type of fabric.

## 3. Guide to understanding labels (p. 5)

The symbols on the labels of your garments are easy to understand and equally important for the success of your wash. The guide includes simple instructions to help you choose the right temperature, wash cycles and ironing methods.

## 4. Useful tips to avoid mistakes (p. 6)

Years back, our grandmothers were the ones who gave us good advice - and in those days synthetic fibres did not exist: washing was easy. Today, your washing machine offers you helpful advice allowing you to wash wool even better than an expert laundress would by hand.

## 5. The detergent dispenser (p. 7)

How to use the detergent dispenser and the bleach compartment.

## 6. Understanding the control panel (p. 3 and 4)

Washing machine's control panel is very simple. It has only a few essential buttons to help you choose any type of wash cycle, ranging from the most energetic, capable of cleaning a mechanic's overalls, to the most delicate for wool. Familiarising yourself with it will help you get the best out of your wash while helping your washing machine last longer. It's easy.

## 7. Guide to the wash programmes (p. 4)

Herein is an easy table to help you choose the right programme, temperature, detergents and possible additives. Choose the right programme and you will get better results with your wash while saving time, water and energy, day after day.



## 8. Care and maintenance (p. 12)

With just a bit of care, it will repay you with loyalty and devotion. With the necessary upkeep, it will wash for years and years to come.

## 9. Problems and solutions (p. 8 and 9)

Before calling a technician, read these pages: immediate solutions may be found for a number of problems. If the problem persists, call your local Indesit customer services who will be pleased to help. Any failure will be repaired, as soon as possible.

## 10. Technical characteristics (p. 9)

Herein are the technical features of your washing machine: model type number, electric and water specifications, size, capacity, speed of the spin cycle and compliance with Italian and European regulations.

## 11. Safety for you and your family (p. 13)

Here you will find the necessary safety guidelines, and it is important for you to read this section carefully.

## 12. Indesit stays with you after your purchase (p. 14)

Indesit supports its products after their purchase by offering you a range of special services, professional assistance, spare parts and quality accessories.

# What goes in your washer?

Dividing your garments according to fabric and colour, is very important for good results

Before washing, you can do a great deal to ensure better results. Divide your garments according to fabric and colour. Read the labels, follow their guidelines.

## Before washing.

Divide your washing according to the type of fabric and colour fastness.

Empty all pockets (coins, paper, money and small objects) and ensure all loose buttons are repaired or removed prior to loading.

## The labels say it all.

Always look at the labels: they tell you everything about your garment and how to wash it in the best possible way.

The table on page 5 shows all meanings behind these symbols. Their recommendations are important to achieve better wash results.

## Big and small happily together.

This washing machine has a special electronic control device for even distribution: before the spin cycle starts, this device allows the garments to position themselves, to minimise noise and vibrations during the spin cycle

## Starting the washer

After installing your new washing machine, start a wash cycle by setting programme "1" at 90 degrees.

Starting your washing machine in the right way is important for the quality of your wash, to help prevent future problems and enhance life expectancy of your appliance. Once you have loaded your washing machine and added the detergent together with any fabric conditioner, always check that:

1. The door is closed correctly.
2. The plug is secured in the socket.
3. The water supply is turned on.

### Turn the appliance on

Press button **C** (position I).

### Choose the desired programme

The programme is selected according to the type of garments that need to be washed. To choose a programme, refer to the table on page 4. Turn knob **A** until the selected programme is aligned with the mark on the knob, set all the options available (flashing) as indicated on pages 3 and 4 (reference ) , then press button **B** (Start/Reset).

If you want to interrupt the programme in progress, press button **B** for at least 3 seconds.

### At the end of the wash cycle...

Wait for symbol  to come off and the word **End** to appear.

Then turn the washing machine off by pressing on-off button **C** (O position). You can now open the washing machine door safely. After having removed the freshly cleaned washing, leave the door open to allow air circulation inside the drum.

Always disconnect electricity at the socket and turn off the water supply.

Remember that, in the event of a power failure, or should the washing machine switch itself off, the programme chosen will remain in its memory.



**For more delicate garments: protect underwear, tights and stockings and delicate items by placing them in a canvas pouch**

## How to eliminate the most common stains

**Ink and biro** Dab with a wad of cotton soaked in methyl alcohol or alcohol at 90°.

**Tar** Dab with fresh butter, rub in turpentine then wash immediately.

**Wax** Scrape away, then run a hot iron between two sheets of absorbent paper. Then rub in cotton with turpentine or methyl alcohol.

**Chewing gum** Rub in nail polish remover and wipe with a clean rag.

**Mold** Cotton and white linen should be placed in a solution of 5 parts water, one bleach and a spoon of vinegar, then washed immediately. For other white fabrics, use hydrogen peroxide at 10 volumes and wash immediately.

**Lipstick** Dab with ether on wool or cotton. Use trichloroethylene for silk.

**Nail polish** Place a sheet of absorbent paper on the side of the stain, wet it with nail polish remover, shifting the garment as the sheet gradually changes colour.

**Grass** Dab with a wad of cotton soaked in methyl alcohol.

## Here I'm in command

Making the right choice is important. And it's easy.



### Programme selector knob

Use this knob to select the wash programme.

To select a programme, you should turn the knob so that the symbol/number of the desired programme is in line with the pointer on the knob.



### Start /Reset

This button allows you to start the selected wash programme or to interrupt it.

If you press it briefly, the button functions as **Start**, if you press it for at least 3 seconds, then it functions as **Reset**.

After the **Start** of the appliance, moving the programme selector knob will have no effect whatsoever.



### On-off

When button **C** is pressed, the washing machine is switched on, when it is not the machine is switched off.

**Turning the appliance off does not cancel the selected programme.**

When the appliance is switched on, all the symbols on the display light up for at least 8 seconds, after which only the ones that can be selected will flash.



### Detergent dispenser

It is divided into three compartments:

1. Detergent for pre-wash;
2. Detergent for the main cycle wash;
3. Fabric conditioner.

The washing machine is equipped with an extra compartment 4 (provided as an accessory) for the bleach, to be inserted in compartment 1.



The detergent dispenser with the additional bleach compartment is here.

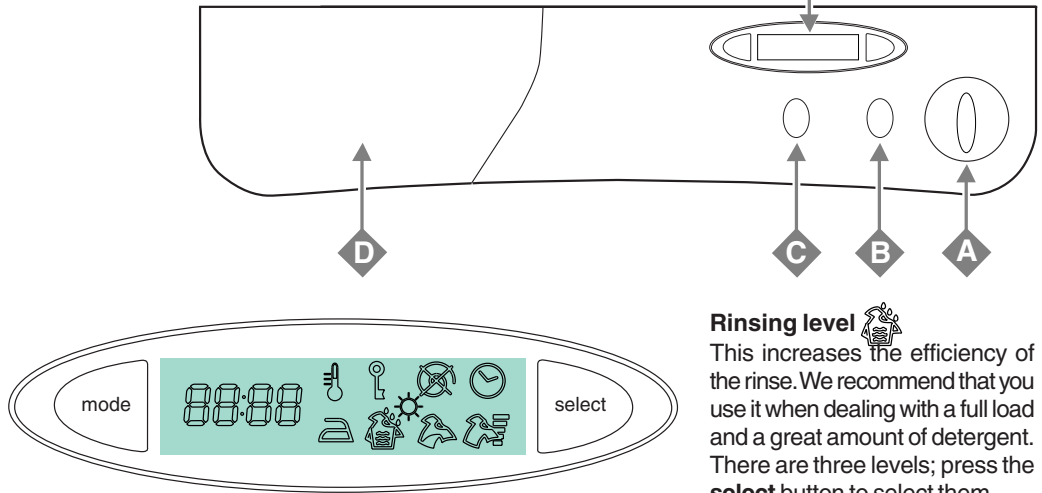

### Display

All the options available are displayed on the right-hand side. Use the **mode** button to select the desired option, and the relative symbol will begin flashing. On the left-hand side, the value or the status (**On-Off**) of the selected option is displayed, and you can modify it using the **select** button.

To access the subsequent option, press the **mode** button, otherwise press button **B** to start the wash cycle.

All the options available are listed below.

**Only options relevant to the selected programme will be displayed.**

### Temperature

The display indicates the maximum temperature relating to the programme set, which can be reduced by pressing the **select** button right down to cold wash (**Off**). This option is available on all wash programmes.

### Spin Variation

The display indicates the maximum speed relating to the programme

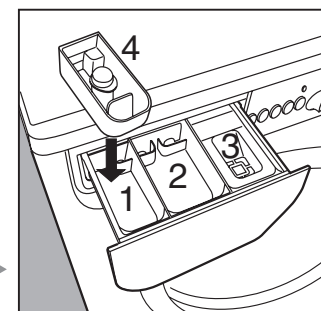

set, which can be reduced by pressing the **select** button right down to its total exclusion (**Off**). During a wash cycle, the selection of the spin cycle exclusion is indicated by symbol coming on. This option is available on all wash programmes except for number 11 and **Drain**.

### Delay Timer

This allows you to delay the start of the wash cycle by a minimum of 1 to a maximum of 24 hours by pressing the **select** button. The enabling of the delayed start is indicated by the symbol coming on and staying on until the wash cycle begins.

This option is not available on the **Draining** and **Spin cycle** programmes.

### Easy Ironing

This function allows your washing to come out of the machine without creases, making it much easier to iron.

The appliance optimises the washing conditions according to the type of fabrics that are being washed.

It is enabled with programmes 3-5-6-7-8-11 and **Rinse cycles**.

To enable it, press the **select** button until the **On** sign comes on. In programmes 6-7-8-11 and **Light Rinse cycles**, the wash cycle is interrupted and the washing is left to soak in water before the appliance is drained. To complete the cycle, press the **select** button. During a wash cycle, the enabling of this option is indicated by symbol coming on.

**Note:** It must not be used with the **Stain Erase** option.

### Rinsing level

This increases the efficiency of the rinse. We recommend that you use it when dealing with a full load and a great amount of detergent. There are three levels; press the **select** button to select them.

Low	
Medium	
High	

This option is available on programmes 1-2-3-4-5-6-7-8 and **Rinse cycles**.

### Stain Erase

(see page 7) Thanks to this command, the washing machine will carry out a more intensive wash that optimises the effectiveness of the liquid additives, thus allowing more resistant stains to be removed.

To use this, press the **select** button until the **On** sign comes on. During a wash cycle, the selection of this option is indicated by symbol coming on.

This option is available on programmes 2-3-5-6-7-8-10 and **Rinse cycles**.

**Note:** It must not be used with the **Easy Ironing** option.

### Wash Intensity

This allows you to modify the characteristics of the selected wash programme, according to how soiled the washing is. There are three levels; press the **select** button to select them.

Low	
Medium	
High	

This option is available on programmes 1-2-3-5-6-7-8.

### Special displays

(left-hand side of the display):

### As soon as you switch the appliance on....

You can display the remaining amount of time of the last wash programme selected.

### Programme length

During the wash cycle, the amount of time left is displayed.

### Error message

In the event of a fault, a message is displayed, (e.g. **F-01**), which should be communicated to the Service Centre.

### End of the programme

At the end of the programme, the word **END** is displayed.

### During the wash cycle....





You can view the characteristics of the programme in progress by

pressing the **mode** button and also modify them, if need be, by pressing the **select** button.

### Door locked

Symbol  on indicates that the washing machine door is locked to prevent it from being opened accidentally. To avoid any damages, you must wait for it to come off and for the word **End** to appear before you open the door.

## What are you washing today? A programme for all seasons

Type of fabric and degree of soil	Programme	Temperature	Detergent for wash	Fabric softener	Stain Erase / Bleach	Length of the cycle (minutes)	Description of wash cycle
<b>COTTON</b>							
Exceptionally soiled whites (sheets, tablecloths, etc.)	1	90°C	◆	◆		140	Prewash cycle, wash cycle at 90°C, rinse cycles, intermediate and final spin cycles
Exceptionally soiled whites (sheets, tablecloths, etc.)	2	90°C	◆	◆	Del./Trad.	125	Wash cycle at 90°C, rinse cycles, intermediate and final spin cycles
Heavily soiled whites and fast colours	3	60°C	◆	◆	Del./Trad.	130	Wash cycle at 60°C, rinse cycles, intermediate and final spin cycles
Heavily soiled whites and fast colours	4	40°C	◆	◆		150	Wash cycle at 40°C, rinse cycles, intermediate and final spin cycles
Slightly soiled whites and delicate colours (shirts, jumpers, etc.)	5	40°C	◆	◆	Del./Trad.	86	Wash cycle at 40°C, rinse cycles, intermediate and final spin cycles
<b>SYNTHETICS</b>							
Heavily soiled fast colour synthetics (baby linen, etc.)	6	60°C	◆	◆	Delicate	94	Wash cycle at 60°C, rinse cycles, anti-crease or delicate spin cycle
Slightly soiled fast colour synthetics (all types of slightly soiled garment)	6	40°C	◆	◆	Delicate	79	Wash cycle at 40°C, rinse cycles, anti-crease or delicate spin cycle
Heavily soiled fast colour synthetics (baby linen, etc.)	7	50°C	◆	◆	Delicate	89	Wash cycle at 50°C, rinse cycles, anti-crease or delicate spin cycle
Delicate colour synthetics (all types of slightly soiled garments)	8	40°C	◆	◆	Delicate	70	Wash cycle at 40°C, rinse cycles, anti-crease or delicate spin cycle
Delicate colour synthetics (all types of slightly soiled garments)	9	30°C	◆	◆		69	Wash cycle at 30°C, rinse cycles and delicate spin cycle
<b>DELICATES</b>							
Wool - Hand wash	10	40°C	◆	◆	Delicate	40	Wash cycle at 40°C, rinse cycles and delicate spin cycle
Particularly delicate garments and fabrics (curtains, silk, viscose, etc.)	11	30°C	◆	◆		60	Wash cycle at 30°C, rinse cycles, anti-crease or draining
<b>PARTIAL PROGRAMMES</b>							
Rinse cycles				◆	◆		Rinse cycles, spin cycles
Light rinse cycles				◆	◆		Rinse cycles, anti-crease or draining
Spin cycle							Draining and spin cycle
Light spin cycle							Draining and delicate spin cycle
Drain							Draining

**Important: to cancel the wash programme you have just set, press button B for at least 3 seconds (Start/Reset).**

*The data found in the table is purely indicative, and can vary according to the quantity and type of washing, the water system temperature and the room temperature.*

### Special programmes

**Class A at 40°C** Your washer has a special programme to allow you to obtain optimum results even at low temperatures.

By setting programme **4** at a temperature of **40°C**, the results you will obtain will be the same as you would normally obtain at **60°C** thanks to the washing machine's action and the length of the wash cycle.





**Daily wash** Your washer has a programme available for the washing of lightly soiled garments in a short amount of time.

By setting programme **9** at a temperature of **30°C**, you can wash different types of fabrics together (except for wool and silk), with a maximum load of **3 kg**. This programme allows you to save on both time and energy as it only lasts around **30 minutes**. We recommend the use of liquid detergent.

# Understanding labels

Learn the meaning of these symbols and you will get better results, your garments will last longer resulting in an improved wash.

All over Europe, garment labels contain messages expressed in small yet important symbols. Understanding them is very important if you want to get better results and treat your garments the way they deserve to be treated.

These symbols are divided in five different categories and shapes: washing , bleaching , ironing , dry cleaning  and drying .

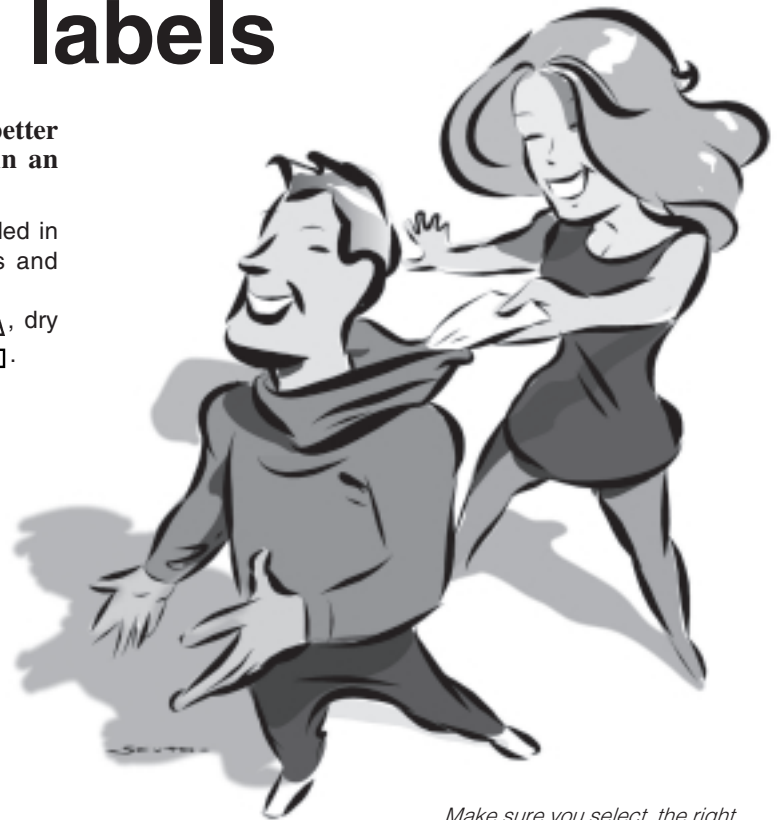

Make sure you select the right temperature!

## Useful tips

































Turn shirts inside out to get better results and make them last longer.

Always empty pockets of their contents.

Look at the label: it will always give you useful advice.

When loading your washing, try to have a mixture of large to small items.

Consult and learn the symbols in this table: they will help you obtain a better wash, treat your clothes properly, and get a better performance out of your washing machine.

Wash		Bleaching	Ironing	Dry cleaning	Drying	
 Strong action	 Delicate action				 High Temp.	 Low Temperat.
 Wash at 95°C		 Bleaching only in cold water	 Hot iron at max 200°C	 Dry clean with any solvent	  Machine dryable	
 Wash at 60°C		 Do not bleach	 Medium hot ironing at max 150°C	 Dry clean only with perchloride, benzine av., pure alcohol, R111 and R113	 Do not machine dry	
 Wash at 40°C			 Iron at max 110°C	 Dry clean with av. benzine, pure alcohol and R113	 Spread to dry	
 Wash at 30°C			 Not ironable	 Do not dry clean	 Hang to dry without spin drying	
Hand wash 					 Dry on clothes hanger	
Not washable in water 						

## Useful tips

■ **Never use your washing machine to wash...** torn, fraying or non-hemmed linen. If it is absolutely necessary, place it in a bag for protection. Do not wash coloured linen with whites.

■ **Watch the weight!**  
For best results, do not exceed the weight limits stated below (figures show weight of dry garments):

- *Resistant fabrics:*  
5,5 kg maximum
- *Synthetic fabrics:*  
2,5 kg maximum
- *Delicate fabrics:*  
2 kg maximum
- *Pure new wool:*  
1 kg maximum

■ **How much does it weigh?**  
1 sheet 400-500 gr.  
1 pillow case 150-200 gr.  
1 tablecloth 400-500 gr.  
1 bathrobe 900-1,200 gr.  
1 towel 150-250 gr.

■ **Coloured T-shirts**, printed ones and shirts last longer if turned inside out before washing. Printed T-shirts and sweatshirts should always be ironed inside out.

■ **Dungaree alert.**  
Very popular "salopette" type overalls have straps with hooks that can damage the drum of your washing machine or other garments during the wash. To minimise the risk, place hooks in the pocket and fasten with safety pins.

■ **Holidays: unplug the appliance.**

It is recommended that you should unplug the machine from the socket and turn off the water supply. Leave the door ajar to allow air circulation to the drum and the door gasket area. This will prevent unpleasant odours.

### WOOL CYCLE

For best results, we recommend you use a specific detergent, taking care not to wash more than **1 kg** of laundry.

## How to wash almost anything

■ **Curtains.**  
Curtains tend to crease a great deal. A useful tip to reduce creasing: fold the curtains and place them in a pillow case or mesh bag. Do not load anything else inside the appliance, this will ensure that the overall weight does not exceed the half load. Remember to use the specific programme **11** which automatically excludes the spin cycle.

■ **Quilted coats and anorak.**  
You can wash quilted coats and wind-cheaters, too, if they are padded with goose or duck down. Do not load more than 2-3 kg and never load 5,5 kg. Repeat rinse once or twice using the gentle spin.

■ **Trainers.**  
Once you have removed mud and dirt from trainers, you can even wash them with jeans or any other tough garments. Do not wash trainers with whites.

## EXCLUSIVE

# Cashmere Gold: As gentle as a hand wash

The first Washing Machine to have "The Woolmark Company" recognition.

The Cashmere Gold wash programme has been studied for its machine wash ability, which enables washing for even the most delicate and valuable of wool or Cashmere garments.

"The Merloni Elettrodomestici wool wash cycle has been tested and approved by The Woolmark Company for

washing Woolmark garments labelled as "hand wash". This is the first gentle action hand wash cycle approved by The Woolmark Company." M.00221

This has been made possible thanks to the speed of the drum at 90 rpm, even during the rinse cycle, thus preventing the fibres from rubbing.

Always use programme **10** with garments bearing the hand wash drawing; represented by the washbasin and the hand.

To take care of your woollen items, we recommend you use special detergents.



It's important for a good wash

# Useful tips about the detergent dispenser

**The first secret is the easiest: the detergent dispenser is opened by pull it outwards.**

You must follow the dosage recommendations provided by the manufacturers when adding detergent or fabric conditioner. Doses will vary according to the wash load, the water hardness and how soiled the washing is. Experience will help you select the right dosage almost automatically: it will become your secret.

Before adding detergent for pre-washing in compartment 1, make sure that the extra compartment for bleach 4 has not been inserted.

Ensure no overfilling when adding fabric conditioner in compartment 3.

The washing machine automatically adds the softener to the wash in each programme.

Liquid detergent is poured into compartment 2 just a few seconds before starting the wash cycle.

Remember that liquid detergent is only designed for wash cycles of up to 60 degrees on non pre-wash items.

Special containers are sold with liquid or powder detergents for placing inside the washing machine drum, these are positioned according to the instructions found in the detergent box

Never use hand wash detergent, because it may form too much foam, which could damage the washing machine.

Detergents that are specifically formulated for both hand and machine wash are an exception.

One last secret: when washing with cold water, always reduce the amount of detergent you use: it dissolves less easily in cold water than in hot water, so part of it would be wasted.

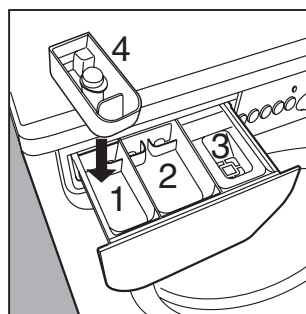

In compartment 1:  
Detergent for pre-washing (powder)

In compartment 2:  
Detergent for washing  
(powder or liquid)

In compartment 3:  
Additives (softeners, perfumes, etc.)

In compartment 4:  
Bleach and delicate bleach.

## Bleach cycle and stain remover button



If bleaching is necessary, the extra case 4 (provided) must be inserted into compartment 1 of the detergent dispenser.

When pouring in the bleach, be careful not to exceed the "max" level indicated on the central pivot (see illustration).

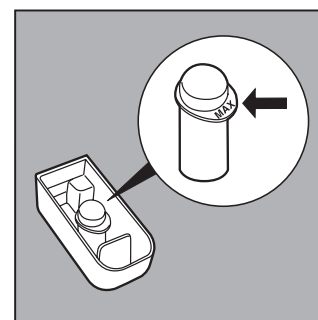
The use of the additional bleach container excludes the possibility of using the pre-wash cycle. **Traditional bleach can only be used on sturdy white fabrics, whereas delicate bleach can be used for coloured fabrics, synthetics and for wool.**



You cannot bleach with the "Silk" programme and with the "special programmes" (see page 4).

Should you wish to bleach **separately**, pour the bleach into extra compartment 4, set the **rinse**  programme for **cotton** fabrics or the **light rinse**  for **synthetics**.

The rinse level should be set to **Medium** or **High** (see page 3).

When bleaching **during a normal wash cycle**, pour in the detergent and additives into the special compartments (see table on page 4), set the desired programme and select the **stain erase** option.

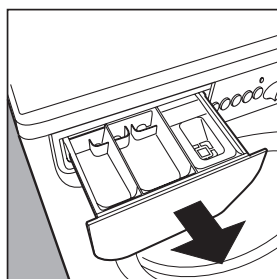

The detergent dispenser can be removed and cleaned: pull it outwards, as indicated in the figure. Then leave it under running water for a few minutes.

## Cutting costs efficiently

### MAXIMISE THE LOAD SIZE

Achieve the best use of energy, water, detergent and time by using the recommended maximum load size.

SAVE up to 50% energy by washing a full load instead of 2 half loads.

### DO YOU NEED TO PRE-WASH?

For heavily soiled laundry only!

SAVE detergent, time, water and between 5 to 15% energy consumption by NOT selecting Prewash for slight to normally soiled laundry.

### IS A HOT WASH REQUIRED?

Pretreat stains with stain remover or soak dried in stains in water before washing to reduce the necessity of a hot wash programme.

SAVE up to 50% energy by using a 60°C wash programme.

### BEFORE USING A DRYING PROGRAMME ...

SAVE energy and time by selecting the highest suitable spin speed to reduce the water content in laundry before using a drying programme.

A guide to environmentally friendly and economic use of your appliance.



## Troubleshooting

# Before calling, read the following

In most cases, when your washing machine fails to work, the problems arising can be easily solved without having to call for a technician. Before calling for assistance, always check these points.

### The washing machine fails to start.

■ **Is the plug correctly inserted into the socket?** It could have been moved whilst cleaning.

■ **Is there electricity in the house?**

A circuit breaker may have switched off as a result of too many electrical appliances working at the same time. Or maybe due to a general failure in your entire area.

■ **Is the washing machine door closed properly?**

For safety reasons, the washing machine cannot work

if the door is open or not shut properly.

■ **Is the On/Off button pressed?**

If it is, then a programmed start has been set.

■ **Has the Start/Reset button been pressed?**

If it is, then a programmed start has been set.

■ **Is the water supply turned on?**

For safety reasons, if the washing machine does not load water, it cannot start a wash cycle.



## RIGHT

## WRONG

Turn off the water supply after use. This will eliminate the possibility of leakage.

Always leave the appliance door ajar to avoid bad odours.

Clean the appliance's exteriors gently. To clean the exteriors and the rubber parts of the appliance, always use a soft cloth dipped in warm and soapy water.

Leave the washing machine plugged in while cleaning. Even during maintenance, the appliance should always be unplugged.

Use solvents and aggressive abrasives. Never use solvents or abrasives to clean the external and rubber parts of the washing machine.

Neglect the detergent dispenser. It is removable and can easily be cleaned by leaving it under running water.

Go on holiday without thinking about her. Before leaving, always make sure that the washing machine is unplugged and that the water supply is turned off.

### But where did all the water go?

Simple: with the new Indesit technology, you need less than half of it, to get good results on twice as much! This is why you cannot see the water through the door: because there is little, very little of it, to respect the environment yet without renouncing maximum cleanliness. And, on top of that, you are also saving electricity.



### The washing machine fails to fill with water.

■ **Is the hose correctly connected to the tap?**

■ **Is there a water shortage?** There could be work in progress in your building or street.

■ **Is there sufficient water pressure?** The autoclave may be malfunctioning.

■ **Is the tap filter clean?** If the water is very calcareous, or if work has recently been carried out on the water piping, the tap filter could be clogged with particles and debris.

■ **Is the rubber hose kinked?** The tract of the rubber hose bringing water to washing machine must be as straight as possible. Make sure it is not squashed or kinked.

### The washing machine continuously fills and drains water.

■ **Is the drain hose positioned too low?** It must be installed at a height ranging from 60 to 100 cm.

■ **Is the end of the hose immersed in water?**

■ **Does the wall drainage system have a breather pipe?** If the problem persists even after these checks, turn the water supply off the machine and call for assistance.

If you live on an upper floor of your building, there may be a problem with your drain trap. To solve this problem, a special valve must be installed.



**The washing machine does not drain or spin.**

- **Does the selected programme incorporate water draining?** Some programmes stop at the end of the wash cycles and draining will have to be selected manually.
- **Is the “Easy ironing” function -where provided -selected?** Complete the programme by pressing the select button.
- **Is the drain pump clogged?** To check it, turn off the water supply, unplug the washing machine and follow the instructions on page 12, or call for technical assistance.

**Always get assistance from authorised technicians and always insist on original spare parts.**

- **Is the drain hose kinked?** The tract of the drain hose must be as straight as possible. Make sure the drain hose is not squashed or kinked.
- **Is the washing machine’s drain duct clogged?** Is there an extension of the drain hose? If so, is it positioned incorrectly, blocking the water flow?



**Excessive vibration during the spin cycle.**

- **Have all transit screws been removed during installation?** See the following page on installation procedures.
- **Has the washing machine been levelled correctly?** The levelling of the appliance should be checked periodically. Adjust the feet and check them with a level.

- **Is there space between the machine and adjacent units?** If it is not a built-in model, the washing machine will oscillate a bit during the spin cycle. A few cm of space should therefore be left around it.



**The washing machine leaks.**

- **Is the metal ring of the inlet hose properly attached?** Turn off the water supply, unplug the appliance and try tightening its attachment without forcing it.
- **Is the detergent dispenser obstructed?** Remove and wash it under tap water.
- **Is the drain hose well attached?** Turn off the water supply, unplug the appliance and try tightening its attachment.



**Too much foam.**

- **Is the detergent appropriate for machine washing?** Check whether the definition on its label reads “for machine wash” or “hand and machine wash”, or any other similar wording.
- **Is the correct amount being used?** An excessive amount of detergent, besides producing too much foam, does not guarantee a more effective wash, and causes scaling in the internal parts of the appliance.

If, despite all checks, the washing machine fails to function and the problem persists, call your nearest authorised Customer Service Centre, providing the following information:

- the nature of malfunction
  - the model type no. (Mod. ....)
  - the serial number (S/N ....)
- This information can be found on the data plate situated at the back of the washing machine.

## Technical characteristics

<b>Model</b>	WE 14
<b>Dimensions</b>	width 59,5 cm height 85 cm depth 53,5 cm
<b>Capacity</b>	from 1 to 5,5 kg
<b>Electrical connections</b>	voltage 230/240 Volt 50 Hz maximum absorbed power 1850 W
<b>Water connections</b>	maximum pressure 1 MPa (10 bar) minimum pressure 0,05 MPa (0,5 bar) drum capacity 46 litre
<b>Spinning speed</b>	up to 1400 rpm
<b>Control programs in compliance with IEC regulation 456</b>	carried out with 5 kg load
	This appliance conforms with the following E.E.C. directives: - 73/23/EEC of 19/02/73 (Low Voltage) and subsequent modifications - 89/336/EEC of 03/05/89 (Electromagnetic Compatibility) and subsequent modifications

# Installation and removal

# When the new washer arrives

Whether new or just transported to a new house, installation is extremely important for the correct functioning of your washing machine.

After removing the appliance from its packaging, check that it is intact. If in doubt, contact a qualified technician immediately. **The inside of the machine is supported, for transportation, by four screws on the back panel.**

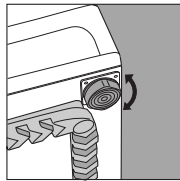

The front feet are adjustable.

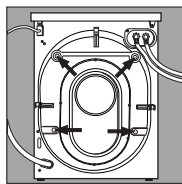

Before using the washing machine, **remove the screws**, remove the spacers together with the rubber tubes attached to them (keeping all the parts) and use the plastic plugs provided to fill in the holes.

**Important:** Use the cap (provided) to close the 3 holes which housed the stop pin, situated in the right-hand part of the lower back of the washing machine.

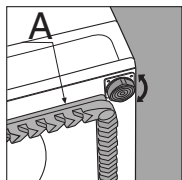

Part **A** must not be removed.

## Levelling

The washing machine must be levelled appropriately in order to guarantee its correct functioning. To level the appliance, the front feet must be adjusted; the angle of inclination, measured according to the worktop, must not exceed 2°. When placed on carpet, make sure the ventilation is not reduced.

**Retain the transit screws, spacers and washers. Should you move house then these should be replaced to support the inside of the machine to prevent damage when transporting the machine.**

## Connection to the water mains

Both hot and cold water supplies are preferable and they should be between 34.5kN/m<sup>2</sup> (5lb/in<sup>2</sup>) and 1034.2kN/m<sup>2</sup> (150lb/in<sup>2</sup>) pressure. The hose having the **red** end fitting should be encountered between the **hot** supply and the threaded connection adjacent to the letter **H** on the rear of the machine. The hose having the **white** end fittings should be connected between the **cold** supply and the threaded connection adjacent to the letter **C** on the rear of the machine. Remember to insert a sealing washer at each connection to ensure watertight joints. **Do not overtighten** the connections by using tools - hand tight is sufficient to prevent leaks. It is generally more convenient to have these supplies away from the sink taps. Where no suitable hot water supply is available or it does not meet these requirements, both inlet hoses may be connected to a cold supply by using two taps etc., or a «T» junction on the plumbing however, use of cold water only will increase programme times.

**Note:** the maximum temperature should not exceed 70°C (158°F).

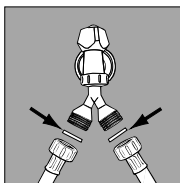

The rubber gasket.

Connect the inlet hose to the threaded connector on the machine rear.

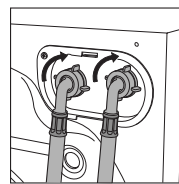

Water pipe inlet at the top right.

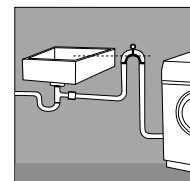
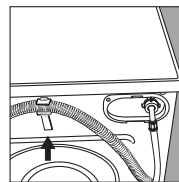

Fig. A

## Connecting the drain hose

The drain hose (hooked pipe) is secured to the rear of the machine by support clips and may be routed to right or left as required.



The hook to be used in case the drain hose ends at a height below 60 cm.

The drain hose should be placed in a stand pipe with a minimum internal diameter of 38 mm (1½ inches) or it can be positioned over a sink or it can be connected as shown in Fig. A. The height of stand pipe or sink should be between 60 and 100 cm (24 and 40 inches). Care must be taken that the hose is not obstructed, twisted, submerged or kinked. If the hose is connected with an airtight joining, provision should be made to prevent syphoning.

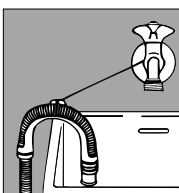

The guide for draining into tubs and sinks.

## Electric connection

Your appliance is now supplied with a 13 amp fused plug it can be plugged into a 13 amp socket for immediate use. Before using the appliance please read the instructions below.

**WARNING - THIS APPLIANCE MUST BE EARTHED. THE FOLLOWING OPERATIONS SHOULD BE CARRIED OUT BY A QUALIFIED ELECTRICIAN.**

## Replacing the fuse:

When replacing a faulty fuse, a 13 amp ASTA approved fuse to BS 1362 should always be used, and the fuse cover re-fitted. If the fuse cover is lost, the plug must not be used until a replacement is obtained.

**Warning!**  
The company denies all liability if and when these norms are not respected.

Plastic bags, expanded styrofoam, nails and other packaging parts are not children's toys, and are potentially dangerous.

**Replacement fuse covers:**

If a replacement fuse cover is fitted, it must be of the correct colour as indicated by the coloured marking or the colour that is embossed in words on the base of the plug. Replacements can be obtained directly from your nearest Service Depot.

**Removing the plug:**

If your appliance has a non-rewireable moulded plug and you should wish to re-route the mains cable through partitions, units etc., please ensure that either: the plug is replaced by a fused 13 ampere re-wearable plug bearing the BSI mark of approval. or: the mains cable is wired directly into a 13 amp cable outlet, controlled by a switch, (in compliance with BS 5733) which is accessible without moving the appliance.

**Disposing of the plug:**

Ensure that before disposing of the plug itself, you make the pins unusable so that it cannot be accidentally inserted into a socket.

**Instructions for connecting cable to an alternative plug:**

**Important:** the wires in the mains lead are coloured in accordance with the following code:

Green & Yellow	<b>Earth</b>
Blue	<b>Neutral</b>
Brown	<b>Live</b>

As the colours of the wires in the lead may not correspond with the coloured markings identifying the terminals in your plug, proceed as follows:

Connect Green & Yellow wire to terminal marked **E** or  $\perp$  or coloured Green or Green & Yellow.

Connect Brown wire to terminal marked **L** or coloured Red.

Connect Blue wire to terminal marked **N** or coloured Black.

If a 13 amp plug (BS 1363) is used it must be fitted with a

13 amp fuse, either in the plug or adaptor or at the distribution board.

If you are in any doubt the electrical supply to your machine, consult a qualified electrician before use.

**How to connect an alternative plug:**

The wires in this mains lead are coloured in accordance with the following code:

BLUE	<b>NEUTRAL (N)</b>
BROWN	<b>LIVE (L)</b>
GREEN & YELLOW	<b>EARTH (E)</b>

**Disposing of the appliance:**

When disposing of the appliance please remove the plug by cutting the mains cable as close as possible to the plug body and dispose of it as described above.

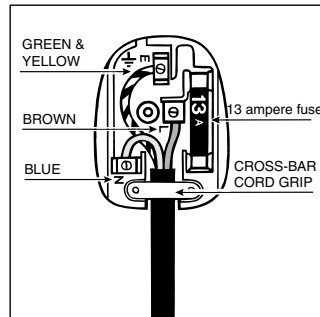

# Easy Care and Maintenance

## Treat your machine well and it will provide many years of trouble free service

Your washing machine is a reliable companion in life and on the job. It is just as important for you to keep it in shape.

Your washing machine is designed to provide reliable service over many years. A few simple steps will help to prolong its life and avoid problems. It is advisable, to turn off water taps when the machine is not to be used, this protects the hoses, etc.

If the water in your area is too hard, use a deliming product (water is hard if it often leaves whitish stains around taps or drains, especially of bath tubs).

For more accurate information as to the type of water in your system, call the local water works or a local plumber).

Pockets must always be emptied removing even pins, badges and any other hard object.

The washing machine exterior should be cleaned with a rag dipped in lukewarm water and soap.

**It is important to wash the detergent dispenser regularly. To prevent dried washing powder from accumulating, place the dispenser under running water for a few minutes.**

### Never exaggerate with doses.

Normal detergents already contain deliming agents. Only if the water is particularly hard, that is, rich in lime content, do we recommend the use of a specific product at every wash. A periodical wash cycle with a dose of a deliming product, without detergents or washing, may prove useful.

Never use too much detergent or additives because this could cause an excess amount of foam, scaling and possible damage to the component parts of your washing machine.



*Do not forget to empty all pockets: small objects can cause damage to your washer.*

## When in need, check the pump and the rubber hose.

The washer comes equipped with a self-cleaning pump that does not require any cleaning or maintenance. Small objects may accidentally fall into the pump: coins, hair clips, loose buttons and other small items. To avoid possible damage, they are withheld in an accessible pre-chamber, situated at the lower end of the pump.

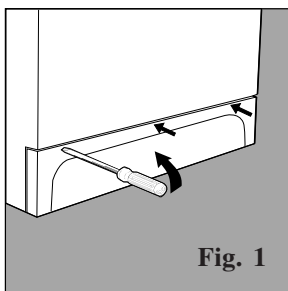

**Attention:** Before attempting to examine this pre-chamber, first ensure that the machine has finished its programme and is empty. Unplug the machine, as with any maintenance.

To gain access gently ease down the top of the plinth panel situated at the base of the machine, with a screwdriver etc, to release it. Then ease the top edge forward to allow it to be lifted clear (Fig. 1). Place a shallow dish or tray below the cover of the pre-chamber to catch the small amount of water present. Release the cover by turning anti-clockwise (Fig. 2). Ensure that the cover is securely replaced. Re-fit the plinth cover by inserting the hooks on its lower edge into the slots and ease the top edge back into position.

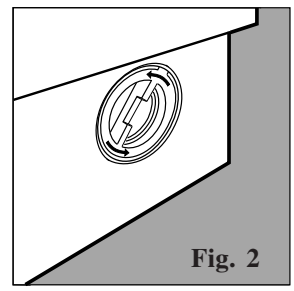

### The water inlet hose

Check the rubber hose at least once a year. If you see any cracks, replace it immediately. When you use your washing machine, water pressure is very strong and a cracked tube could easily split open.

# Important for the safe use of your washing machine

# Your safety and that of your family

Your washer has been built in compliance with the strictest international safety regulations. To protect you and all your family.

Read these instructions and all the information in this manual carefully: they are an important source, not only of numerous useful tips, but also of vital information on safety, use and maintenance.

1. **the machine should not be installed in an outdoor environment**, not even when a roof shelters the area, because it may be very dangerous to leave it exposed to rain and thunderstorms.
2. **It must only be used by adults** and exclusively for washing clothes following the instructions provided in this manual.
3. Should it have to be moved, proceed with the help of two or three people and handle it with the utmost care. Never try to do this alone, because **the appliance is very heavy**.
4. Before loading the washing machine, **make sure the drum is empty**.

5. **Never touch the washing machine when barefoot or with wet or damp hands or feet.**
6. **Never use extensions or multiple plugs**, which are particularly dangerous in humid environments. The power supply cable must never be bent or dangerously compressed.

**I only want an authorised specialised technician with original Indesit spare parts!**



7. **Never open the detergent dispenser while the appliance is functioning; do not use hand wash detergent** because the abundance of foam could damage its internal parts.
8. **Never pull on the supply cable** or the washing machine to disconnect it from the wall socket: it is extremely dangerous.
9. While the appliance is functioning, **do not touch the drain water** as it could reach very high temperatures. **The appliance door, during wash cycles, tends to become hot; ensure that children do not touch it. Never force the washing machine door** because this could damage the safety lock which prevents accidental opening when the machine is working. Allow a few minutes at the end of the program for the lock to release.
10. **In case of malfunctioning, first close the water tap and unplug the appliance from the wall socket; do not under any circumstances touch internal parts in order to attempt repairs.**

## How to change the power supply cable

(For this operation we suggest you contact a qualified engineer)

**The washing machine power supply cable is special and can be purchased exclusively from authorised Technical Service Centres.**

To replace the cable:

1. **Make sure that the machine is switched off and unplugged.**

2. Remove the covering lid by unscrewing the two screws **I**, and then pull it towards you [fig. 3].

3. Disconnect the wires from the radio interference suppressor **F** [fig. 4] noting as to their position (**Blue=N** wire; **Brown=L** wire) leaving the earth wire until last  $\perp$ .  
N.B.: letters **L**, **N** and the

symbol  $\perp$  are indicated on the radio interference suppressor.

4. Remove the upper part of the cable slightly from the back panel of the appliance, pull the power supply cable upwards and take it out [fig. 5].

**To connect the new power supply cable, reverse the procedure.**

To put the covering lid back on, rest it on the washing machine [fig. 6] and let it slide forwards until the hooks situated on the front slide into the special slots formed into the control panel and tighten the screws back on.

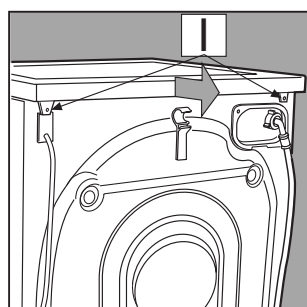

Fig. 3

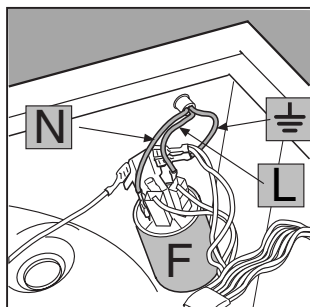

Fig. 4

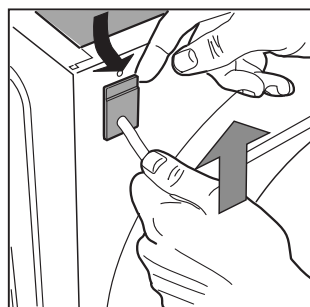

Fig. 5

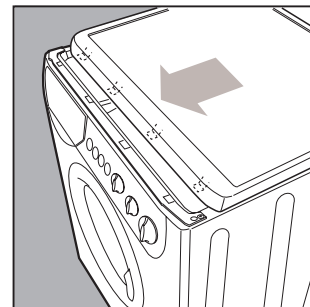

Fig. 6

# Stay in touch



**THANK YOU** for choosing an **Indesit appliance**. We are confident you have made a **good choice** and that your new appliance will give **many years of excellent service**.  
And we're **there when you need us**.

## Register your purchase now

This will confirm your entitlement to enter our **quarterly prize draw** where you have the possibility to recover the cost of your purchase. Simply complete and return the **Registration Form** supplied with the appliance documents, using the **FREEPOST envelope** supplied. Or call the **Registration Hotline** on **0870 010 4305**.

## We're as close to you as your telephone

For direct access to **Genuine Indesit Spare Parts and Accessories**, call **0870 558 5850** and speak to our skilled staff who can help you to identify and purchase the item you require.

For a **Rapid Response** to a **problem with your appliance**, call **0870 607 0805**. We're open from Monday to Saturday (8am - 5.30pm weekdays, 9am - 5pm Saturday). We have our own department of highly trained Indesit service staff. For most calls, our Service Engineer can fix the problem on the first visit.

Please have the following details to hand when you ring us:

The **nature** of the problem, the **Model Number** and the **Serial Number**.

These numbers can be found on the appliance and on the portion of the Registration Card which you retain.

# Merloni Elettrodomestici

Viale Aristide Merloni 47

60044 Fabriano

Italy

Tel +39 0732 6611

Fax +39 0732 662501

[www.merloni.com](http://www.merloni.com)



Leader for young Europe